

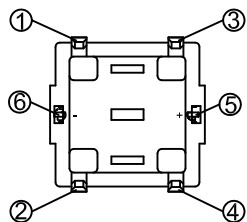

TS6

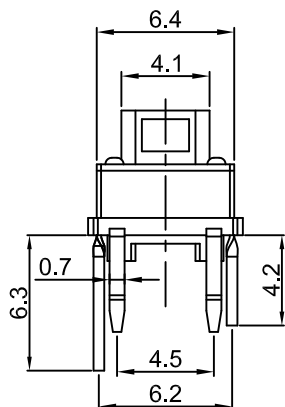
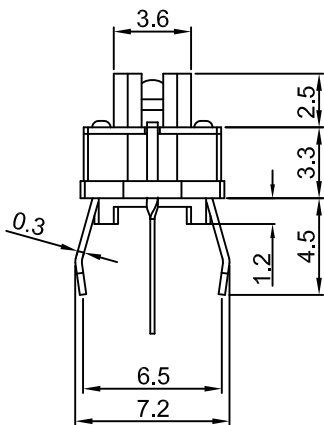
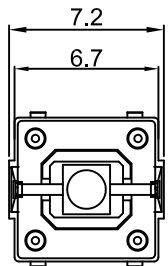
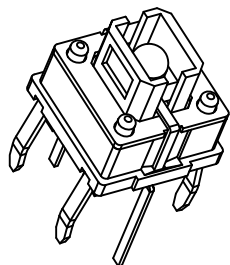

Specifications

- Circuit :SPST
- Current rating :50mA
- Voltage rating :12VDC
- Dielectric withstanding voltage :250VAC for 1 minute
- Contact resistance :100m Ω Max. (Initial)
- Insulation resistance :100M Ω Min.
- Operating force :250±50gf
- :180±50gf
- Total travel :0.25mm±0.1mm
- Operating life :100,000 cycles Min
- Solder specifications :260° C for 5 seconds
- Function :Momentary
- Operating temperature :+10° C ~ +60° C

P.C.B. LAYOUT

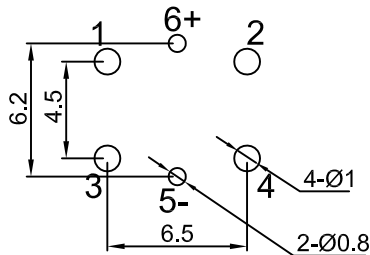

CIRCUIT

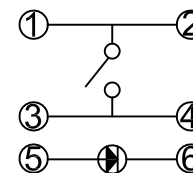

MATERIAL:

- Base Frame:Nylon46,UL rated:94V-2 Min. ;
- Top Cover:PET,UL rated:94V-2 Min. ;
- Actuator: Nylon66, UL rated:94V-2 Min. ;
- Terminal:Brass with Silver-plate.

BG	纯绿色	3.2	3.7	4.2	20	120	515	525
W	白色	2.8	3.4	3.8	20	120	XY	XY
O	橙色	1.8	2.2	2.4	20	120	620	634
RU	蓝色	2.8	3.2	3.4	20	120	460	470
	红色	1.8	2.2	2.4	20	120	620	630
U	蓝色	2.8	3.2	3.4	20	120	460	470
G	黄绿色	1.8	2.2	2.4	20	120	563	575
Y	黄色	1.8	2.2	2.4	20	120	582	588
R	红色	1.8	2.2	2.4	20	120	620	630
灯发光颜色 X Emitted color X		最小	一般	最大	最大操作电流 (mA)	最大脉冲电流 (mA)	主波长 (nm)	峰值波长 (nm)
		顺向电压(V)						

		公差 TOLERANCES		.X± 0.3 .XX± 0.15		角度 ± 1°		单位 DIMENSION UNIT mm.	
		版本 VERSION	A1	比例尺 SCALE	NONE	日期 DATE	2020.07.15	品名 TITLE	
		核准 APPROVED BY	王龙	核对 CHECKED BY	Z. H. B.	绘图 DRAWN BY		图号 DRAWING NO	
版本 VER.	变更说明 CHANGE DESCRIPTION	日期 DATE	ECN NO.	APPROVED BY	王龙	CHECKED BY	Z. H. B.	绘图 DRAWN BY	TS6-00-00-Y
								TS6-00-00-Y_A1	