

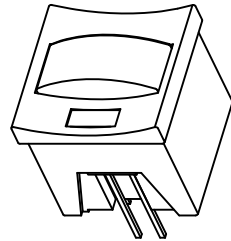

PB07

Rating: 0.1A 30V DC  
 Contact Resistance: 100mΩ Max  
 Insulation Resistance:DC 500V 100MΩ Min  
 Dielectric Strength:AC 250V for 1 minute  
 Total travel:2.5±0.4mm  
 Operating Force:200±50gf  
 Operating Life:50,000 cycles  
 Operating Temperature:10°C~60°C

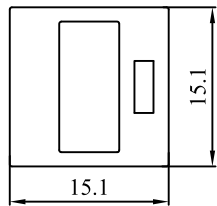

Contact Configuration:

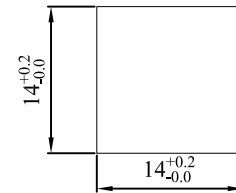
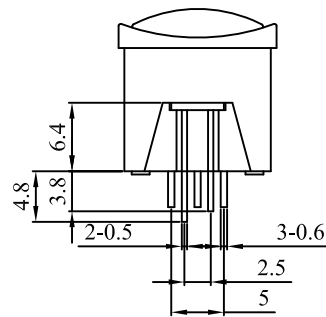
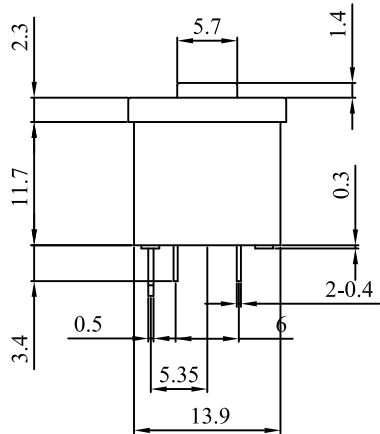
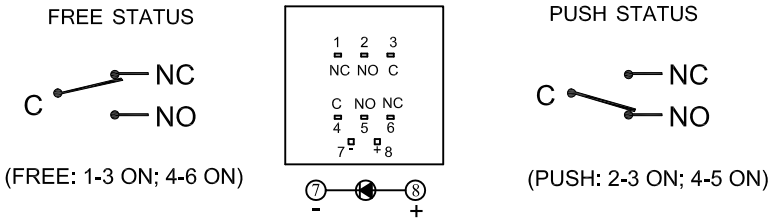

PANEL HOLE

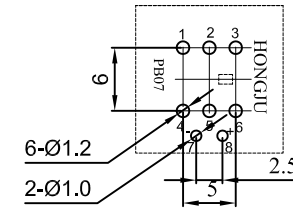

PCB HOLE( BOTTOM VIEW)

MATERIAL:

Outer Frame: ABS;  
 Base: ABS;  
 Actuator: ABS;  
 Terminal:Brass,Silver or Tin plated.

RG	颜色	1.8	2.2	2.4	20	120	567	575	Y	Yellow	黄色
	颜色	1.8	2.2	2.4	20	120	625	630	W	White	白色
U	蓝色	3.0	3.2	3.4	20	120	460	480	U	Blue	蓝色
G	黄绿色	1.8	2.2	2.4	20	120	567	575	R	Red	红色
O	橙色	1.8	2.2	2.4	20	120	600	610	G	Green	绿色
R	红色	1.8	2.2	2.4	20	120	625	630	B	Black	黑色
	灯发光颜色	最小	一般	最大	最大操作电流	最大脉冲电流	主波长	峰值波长	A	Gray	灰色
	Emitted color	期向电压(V)			(mA)	(mA)	(nm)	(nm)	CAP	Color	(X)

				公差 TOLERANCES			.X± 0.3 .XX± 0.15 角度 ANGLE± 1°			单位 DIMENSION UNIT mm.		
				版本 VERSION	A1	比例尺 SCALE	NONE	日期 DATE	2020.08.27	品名 TITLE		图号 DRAWING NO
				核准		核对	Z.H.B.	绘图	HXG	PB07-RB-0R0		PB07-RB-0R0_A1
版本 VER	重新整理发行			日期 DATE	2020.08.27	变更说明 CHANGE DESCRIPTION			日期 DATE	ECN NO.	APPROVED BY	